



OREGON

**DESIGN GUIDE &
INSTALLATION MANUAL**

Bord na Mona Environmental Products US Inc.
P.O. Box 77457, Greensboro, NC 27417
☎: 800 787 2356 Fax 336 547 8559
www.bnm-us.com

Contents	Page
1.0 GENERAL DESCRIPTION OF SYSTEM	4
2.0 PROCESS FUNDAMENTALS	5
2.1 Treatment Mechanisms	5
2.2 The Microbiology of the System	5
2.3 Treated Waste Water Quality	6
3.0 SYSTEM DESIGN & SPECIFICATION	7
3.1 System configuration	7
3.2 Design flow & number of modules	7
3.3 Septic tank	7
3.4 Time dosed pump tank	7
3.5 Biofilter modules	8
3.6 Cold weather conditions	8
3.7 Life of the peat fibre media	8
3.8 The final disposal system	8
4.0 SYSTEM LAYOUT & COMPONENTS	9
4.1 Schematics of Puraflo® System Components	9
4.2 Specification of Puraflo® Module	10
5.0 INSTALLATION REQUIREMENTS	11
6.0 ELECTRICAL REQUIREMENTS	11
7.0 SEQUENTIAL INSTALLATION PROCEDURE	12
7.1 Site Clearance	12
7.2 Septic Tank	12
7.3 Pump Tank Installation	12
7.4 Pump Fittings and Pipework	12
7.5 Puraflo installation	13
7.6 Electrical Connections	13
7.7 Spare Parts	14
7.8 Site Restoration	14
APPENDIX 1 TYPICAL SEPTIC TANK AND PUMP TANK DETAIL	15
APPENDIX 2 TYPE B – PIPED OUTLET DISPOSAL METHOD SCHEMATIC	16

1.0 GENERAL DESCRIPTION OF SYSTEM

The Puraflo® Peat Biofilter is an advanced secondary treatment system that purifies septic tank effluent to an extremely high degree before final disposal.

A typical Puraflo® Peat Biofilter system consists of:

1. A septic tank fitted with an effluent filter on the outlet pipe.
2. A dosing tank and effluent pump or siphon to accommodate dosing of the septic tank effluent onto the peat fibre media.
3. Biofilter modules where advanced treatment occurs due to the physical, chemical and microbial processes that are optimized in the peat fibre media.
4. The site specific final effluent disposal system.

The filtered septic tank effluent is collected under gravity in the pump tank. A time dosing system is activated by a programmable timer, which pumps the effluent through a flow splitting inlet manifold located at the base of the treatment modules. An orifice plate is located inside the top of each inlet manifold which allows the flows to be split equally and fed simultaneously to each biofilter module. The inlet manifold is connected to the base of the biofilter and is fed upwards to a rectangular distribution grid located 6 inches below the top of each module. The effluent percolates laterally and vertically through the depth of the peat fibre treatment media and emerges as a clear innocuous liquid from the base of the system, for collection and dispersal.

The Puraflo® Peat Biofilter System for wastewater treatment has been tested, certified and listed by NSF International as meeting the requirements of ANSI / NSF Standard 40, Class 1.

The Puraflo is a modular system with each module rated for 150 gpd. The range and rated capacity of the system is therefore a multiple of the standard unit based on the 150 gpd module. Model P150N*3B incorporating 3 modules and rated at 450 gpd was the treatment plant tested to the NSF/ANSI Standard 40.

Puraflo® Peat Biofilter

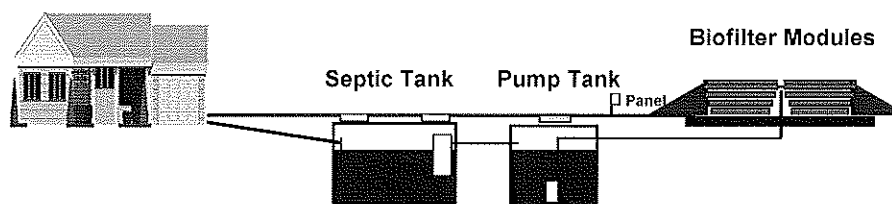

Bord na Móna

2.0 PROCESS FUNDAMENTALS

2.1 Treatment Mechanisms

The peat fibre treatment technology is based on simple, passive biofiltration principles. The treatment of the wastewater within the system is achieved by a combination of unique physical, chemical, and biological interactions between the wastewater and the fibrous peat media.

Extensive scientific examination of the peat fibre media has revealed a complex structure which permits a number of separate treatment and attenuation processes to occur simultaneously. The treatment mechanisms within the fixed film media can be summarized as follows:

<u>Physical:</u>	Filtration, Adsorption
<u>Chemical:</u>	Adsorption, Ion exchange
<u>Biological:</u>	Microbial assimilation

The residence period or contact time in the media at the design loading rate has been calculated and shown to be somewhere between 36 and 48 hours by using tracer organisms.

2.2 The Microbiology of the System

In a mature peat fibre unit the biological processes are known to be crucial in maintaining the treatment efficiency observed. The bulk of the treatment and assimilation processes are achieved by diverse microflora which adhere to the surface of the peat media. This microflora is largely composed of aerobic and facultatively aerobic heterotrophic bacteria from a large number of genera. The most important bacteria genera represented include:

Pseudomonas	Aeromonas
Bacillus	Micrococcus
Flavobacteria	Alcaligenes
Streptococcus	

The total bacterial population recorded per gram of peat has been measured at 1×10^9 cfu's. Similarly, high numbers (up to 1×10^7 cfu/g) of fungal organisms have been isolated from the Puraflo® units. A wide variety of "higher life" forms have also been recorded within the media matrix (ranging from protozoans, rotifers, and algae to nematode and annelid worms, insects and their larvae). These organisms play an important role in keeping the bacterial population "in check" thereby maintaining balanced microflora and ultimately a stable ecosystem.

The larger numbers of heterotrophic bacteria are found in the upper portions of the filter media with nitrifiers becoming more prevalent at depths of 12" or greater. Therefore, the degradation and assimilation of the carbonaceous elements of the waste is affected within the upper portions of the filter bed with nitrification occurring at greater depths.

The peat fibre system is also very effective at eliminating enteric bacteria contained in the waste. The anti-microbial properties of the system can be classified under two broad headings:

1. The aggressive nature of the peat media

The anti-microbial properties of the acidic peaty soils are developed through the low pH which directly affects the cell walls of the organisms in addition to limiting the amounts of nutrients available for uptake. Also, the trace amounts of phenols, bitumes and other complex hydrocarbons which are associated with peaty materials are directly toxic to certain bacteria, in particular enteric organisms which find themselves in a hostile environment (low temperature high competition etc.) and are already

in a stressed condition. Finally, certain peaty soils have been demonstrated to contain a significant fungal species population (in addition to certain actinomycetes) which produce antibiotics and thus can adversely affect bacterial species in the zone of influence. It is important to note that the natural antimicrobial properties of the peat media are only effective on the "stressed" enteric organisms contained in the primary wastewater. The indigenous microflora associated with the treatment media are largely unaffected by the properties described.

2. Microbial antagonism

The second means by which the enteric organisms are extinguished in the Puraflo system is by microbial antagonism. This simply means that the stressed micro-organisms within the primary wastewater are out competed by the indigenous microflora. The low temperature, low pH and production of certain microbial toxins within the peat media adversely affects the "foreign" organisms. As such, they are largely ineffective in assimilating nutrients etc. which are necessary for their survival. The large retention time in the filter bed ensures that die off is maximized.

The treatment efficiency in the unit is not subject to significant variation with ambient air temperature fluctuations.

2.3 Treated Waste Water Quality

When treating domestic strength wastewater up to the design flows and loads a properly maintained Puraflo® system will exceed the performance requirements of NSF Standard 40 Class 1. Actual NSF test results established through analytical methods described in ANSI / NSF 40 averaged 2mg/l CBOD and 2 mg/l TSS.

PARAMETER	NSF 40 Standard 30-d average	Puraflo Average Concentration
CBOD (mg/l)	25	2
TSS (mg/l)	30	2
pH (pH units) range	6 - 9	6 - 7.5

Additional NSF testing results are reproduced in the following table.

PARAMETER	Puraflo Average Concentration
Total Nitrogen	>70% reduction
NH ₃ -N (mg/l)	<1
Fecal Coliform elimination	99.9% removal

The pH, CBOD and Suspended Solids (T.S.S.) concentrations demonstrated in this table will be attained within a few weeks of commissioning and will be consistently achieved over the lifetime of the peat fibre media.

3.0 SYSTEM DESIGN & SPECIFICATION

The Puraflo® Peat Fibre Biofilter is a pre-engineered treatment system contained in factory pre-assembled molded polyethylene modules. It is a highly efficient system for the treatment of domestic strength wastewater and is designed to minimize site construction. Domestic quality primary effluent is evenly distributed over the specialized fibrous peat fibre media. One biofilter module (approx. 7ft. long x 4.5 ft. wide x 2.5 ft. high) is designed to treat the wastewater from one bedroom, 2 people or a design flow of up to 150 gals/day of domestic strength wastewater. Guideline hydraulic and organic loading rates per module are as follows:

Maximum design organic loading per module 0.3755 lbs/day

Maximum design hydraulic loading per module 150 gal/day

3.1 System configuration

The designer of a Puraflo® System will be responsible for proper configuration and sizing of the components of the system, pump and other peripheral component specifications, timer settings, and construction details.

3.2 Design flow & number of modules

Applicable regulations usually define the daily flow based on the number of bedrooms or the number of occupants with a defined flow per person per day. Bord na Mona research has determined that one module per bedroom or one module per 150 gallons is required to treat domestic strength wastewater.

3.3 Septic Tank

The size and configuration of the septic tank shall be in accordance with applicable Local and State Regulations. The septic tank shall be watertight and have a usable volumetric capacity of at least 24 hours retention.

Specify a 1/32 inch effluent filter which should be installed on the septic tank outlet pipe to prevent grease and solids carryover into the pump tank.

3.4 Time dosed pump tank

Dosing is typically regulated from a control panel with programmable timer, low water cut-off float switch (timer enable) and high water level alarm. The low water cut-off switch should ensure that the pump remains covered at all times. There should be storage capacity above the high water alarm float equal to or greater than one quarter of the daily design flow. The flow equalization zone (between the low water cut-off and high water alarm floats) should be approximately half the daily flow to avoid nuisance alarm activity. A watertight 1000 gallon pump tank is usually adequate for a typical 3-4 bedroom domestic application.

The dosing volume should be approximately 5 to 15 gallons per module per cycle. For example, a 2 hour dosing interval for a 450 gpd three module system would result in 12 doses at 37.5 gallons per dose. This equates to 12.5 gallons per module per dose. If the force main is set up to drain back, the drain back volume should be factored into the dosing calculations.

The diameter of the force main and Puraflo outlet pipe manifold (where applicable) are typically 2 inch sch 40 PVC piping on a 3 module system

Buoyancy calculations for the septic tank and pump tank should be performed when necessary.

3.5 Biofilter Modules

Effluent from the force main is distributed to the modules via a flow splitting manifold with pressure equalizing orifice plates. Effluent is distributed over the peat media by a pre-installed rectangular grid with large diameter openings to prevent clogging. The effluent charges the grid using the velocity generated by the orifice plates; it is not a pressurized distribution grid.

The site specific design will detail the final effluent disposal method. Effluent will be discharged directly to a piped outlet for discharge to trench, pressure systems, point discharge systems or other effluent disposal methods as applicable.

Modules are pre-assembled for effluent disposal

- a) a piped outlet for connection to another dispersal system (White Module color code)

It is important to specify which modules are needed for a particular design. The type of module is designated by a painted triangle on the module lid.

Effluent disposal methods are used, such as trenches, the (white) modules have piped outlets, are sealed (the modules do not have weep holes) and the effluent exits each module via two gravity drain lines. The effluent is then piped and distributed to the effluent disposal system via an in-line sample port.

3.6 Cold weather conditions

Certain precautions should be taken in extreme cold weather conditions. In particular, the force main should be designed to drain back after each cycle. In general, accepted standard practice for cold weather conditions should be adopted.

3.7 Life of the media

The effective life of the Puraflo® peat fibre media is estimated to be in the order of 15 years where the system has been subjected to design flow and loadings, has been designed & installed in accordance with the design guidelines & installation instructions and has been maintained in accordance with the Operating & Maintenance instructions and regulatory permit.

3.8 The final disposal system

The final disposal system is to be designed in accordance with local regulations and manufacturers guidelines.

Schematics of Puraflo® System Components

Part No.	Description	Part No.	Description
1	Septic Tank (Table 1)	8	Ball Valve
2	Effluent Filter (Table 2)	9	Union Disconnect
3	Sewer Line	10	Time Dose Control Panel
4	Riser and Lid	11	Force Main
5	Pump Tank	12	Puraflo® Module(s)
6	Pump	13	Stone Pad
7	Floats		

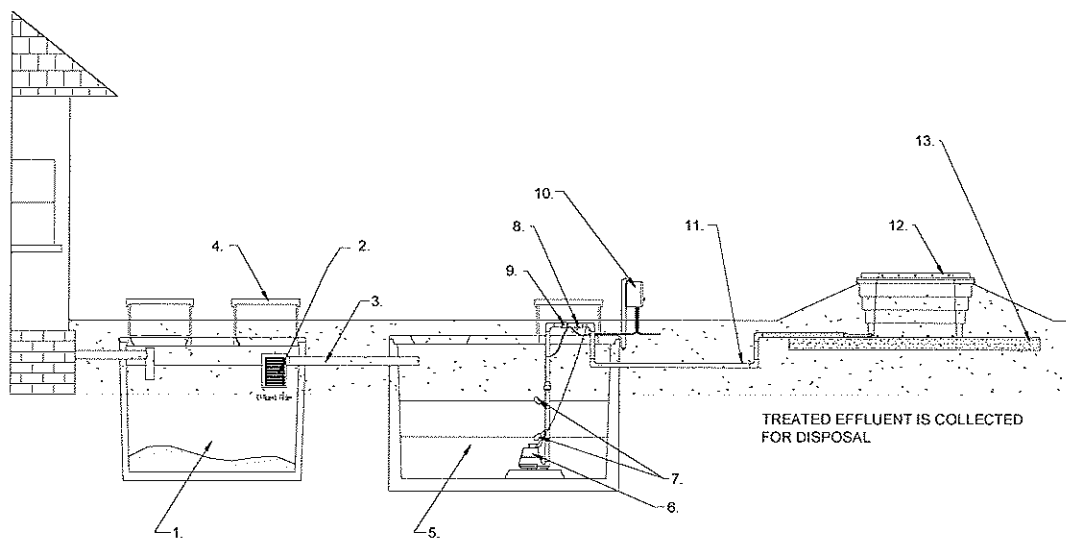

LIST OF PURAFLO SYSTEM COMPONENTS

Table 1.

Approved Tank Manufacturer	Tank Size	Inlet Sanitary Tee	Outlet liquid Level
Hanks Concrete Products	1000 gallon Septic Tank	41"	34"
Willamette Graystone Inc.	1000 gallon Septic Tank	54"	48 ¹ / ₂ "

Table 2.

Approved Effluent Filter Manufacturer	Model	Filtration
Zabel (Polylok)	A-300 8" x 18" VC	1/32"

4.2 Specification of Puraflo® Module

Max Treatment Capacity per Module	150 G.P.D.
Module Length	7' 1"
Module Height	2' 6"
Module Width	4' 6"
Module Weight	≈1800 lbs

Part No.	Description	Part No.	Description
1	Inlet	6	Distribution Grid
2	Drain Hole Outlet	7	Vent Holes
3	#5 Stone	8	Rope Handle Holes
4	Peat Fibre Media	9	Stabilizer Bars
5	Distribution Orifice		

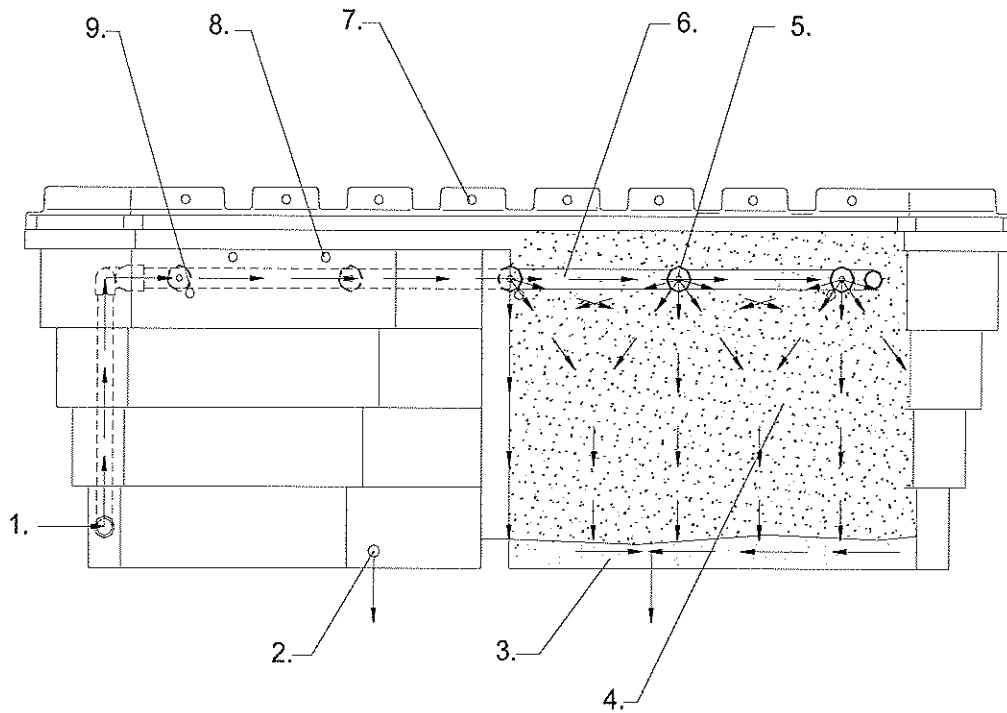

PURAFLO MODULE

Typical Septic Tank and Pump Tank Detail.

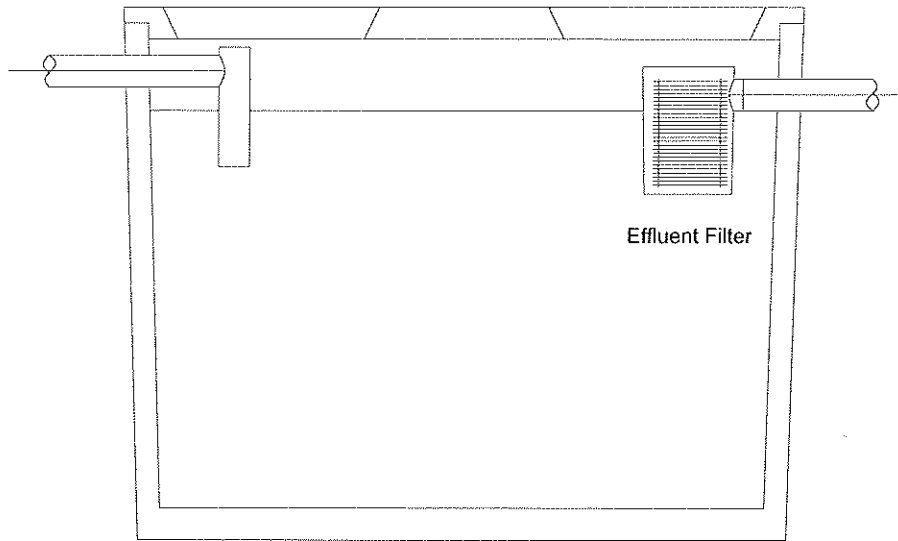

OREGON APPROVED SEPTIC TANK DETAIL
 (dimensions, construction and installation should conform to applicable local and state regulations)

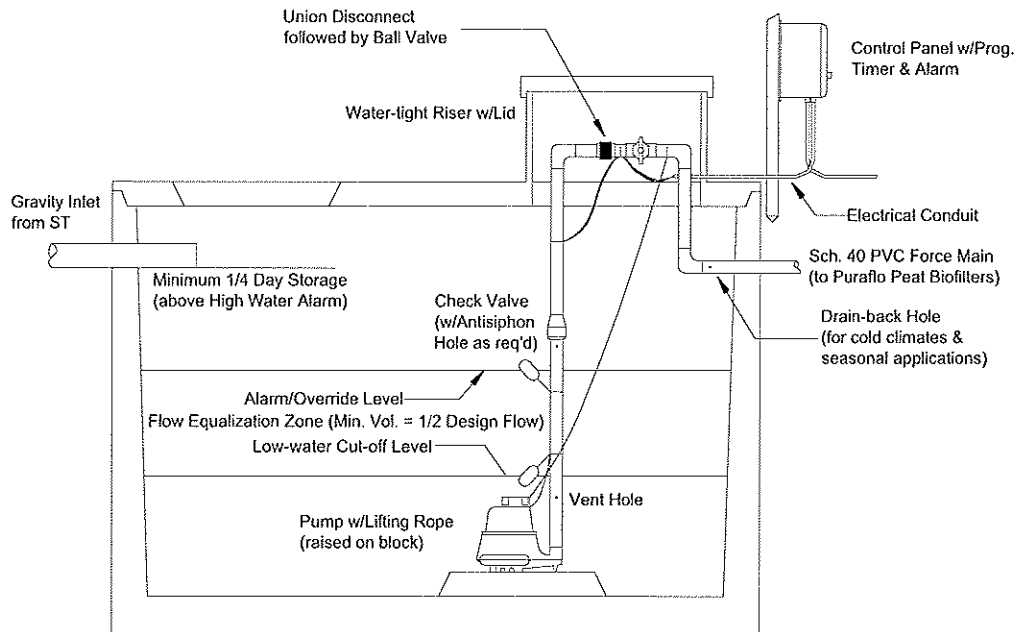

TYPICAL PUMP TANK DETAIL
 (dimensions, construction and installation should conform to applicable local and state regulations)

5.0 INSTALLATION REQUIREMENTS

Installation of the Puraflo® system is straight forward and can usually be completed in less than a day.

- ⚠ **Warning:** Use recognized, safe lifting techniques to off-load and set modules. Ensure all lifting equipment is clear of overhead obstructions such as power lines, trees, rooftops or any other construction. Always be careful. Place the lifting equipment on solid, stable ground. Use a 4-point sling or equivalent (see below).

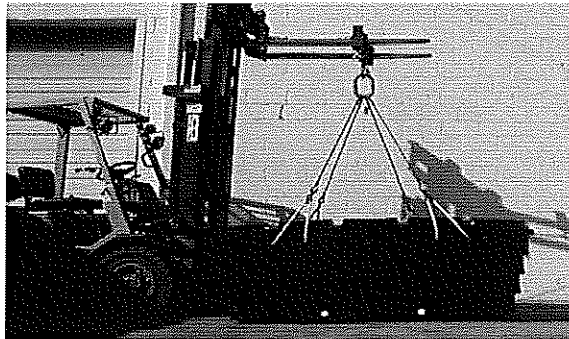

The contractor/ installer is required to provide the following:

- Mechanical excavator (back-hoe) with operator
- An electrician qualified to undertake the work in accordance with local regulations (the electrician will be required to connect the pump and alarm to the control panel, set timer as required, and connect the control panel/junction box with the main power supply)
- Provide and supervise the installation of the underground cable from the control panel/junction box to the main circuit board
- Provide Gravity & force main Sch. 40 PVC piping and fittings as per design
- Clean No. 5 ($3/4$ to 1 inch) stone as required
- Additional/imported fill material (typically not sand) and topsoil as required
- Labor as necessary to install the system
- Necessary supervision to ensure the system is installed per design

6.0 ELECTRICAL REQUIREMENTS

An independent electrical supply to power the control panel - (120/220 volts and 20 amps typical) is to be made available.

These requirements may change by state or when a duplex panel, a larger pump or a high head pump is required per design - please refer to site specific design to verify electrical requirements noting the requirement for 120 or 220 volts and the amps rating required at site.

7.0 SEQUENTIAL INSTALLATION PROCEDURE

7.1 Site Clearance

- Clear Site vegetation as required (minimize site disturbances)
- Provide sufficient access to proposed system

7.2 Septic Tank

- Supply and install septic tank and sewer pipe from the dwelling in accordance with applicable State regulations. The septic tank must be watertight against ground and surface water infiltration.
- Install septic tank on stable, compacted ground and backfill with suitable material as recommended by the manufacturer.
- Fit an effluent filter (1/32" specification) on the outlet pipe.
- Install water tight risers over inlet and outlet manholes to provide access for filter maintenance, desludging, etc.
- Backfill & grade around the septic tank to prevent infiltration of surface water.

See Appendix 1:- Typical Septic Tank Detail

7.3 Pump Tank Installation

- Supply and install the pump tank in accordance with applicable State regulations. The pump tank must be watertight against ground and surface water infiltration.
- Install pump tank on stable, compacted ground and backfill with suitable material as recommended by the manufacturer.
- Install gravity main from the septic tank to the pump tank in accordance with applicable State regulations.
- Excavate a trench typically 18 inches deep from the pump tank to the location of the modules. In colder climates the force main may be buried deeper (below frost line).
- Place sufficient risers on top of the pump tank to reach slightly above grade level. It is extremely important to ensure a watertight seal between the pump tank and the first riser and between individual risers.
- All connections/seals should be made water tight in accordance with manufacturer's recommendations.
- Backfill, compact and landscape around the pump tank inlet / outlet pipes and electrical cable points of entry. Ensure suitable backfill material is used in accordance with manufacturers instructions.

7.4 Pump Fittings and Pipework

- Place the base of the pump approximately 6 inches above the base of the pump tank.
- Glue required length of PVC force main into the fitting at the outlet of the pump. Install the required fittings (check valve, union, ball valve, etc. as required by the design). Note; in most

cases a 2 inch forced main is specified so a bushing (1¹/₂ inch x 2 inch) may be required to connect the internal pump tank piping to the pump. In some cases, the force main may be designed to drain back and a drain back hole will be required above the check valve. Install an air vent hole when required and an anti-siphon hole if the module grid is lower than the liquid level in the pump tank.

- Floats are generally used however other suitable level devices may be installed. Install on/off float typically at pump level (to ensure that the pump is kept submerged). Install alarm float with 1/2 day storage above the on/off float. Strap floats to force main or separate stand pipe or hang from bracket.
- Install the force main in the trench from the pump tank to the modules. Backfill trench once the line is correctly installed and connected. Be careful not to damage the installed force main line with heavy vehicle activity.
- See Appendix 1:- Typical Pump Tank Detail

7.5 Puraflo Installation

The site specific design will detail the final effluent disposal method. Effluent may be discharged to any system allowed under state or local regulations. The model numbers are identified as B for a piped outlet installation.

Type B – Piped Outlet Installation

See Appendix 2:- Type B – Piped Outlet Schematic

- For piped outlet installations the pad area's primary function is to level and support the modules.
- Excavate a pad area (as specified in the design). The pad bottom must be level.
- Fill and level the excavated area with a 6" base of sand or stone, stone may range from 1/2" to 2".
- Position the modules on the stone pad area. Connect the force main to the module inlet coupling (incorporating a flexible pipe). Construct the outlet pipework to the sampling chamber and to the final disposal system in accordance with the design.
- Backfill with stone around the modules to a height of 6 inches above the drain holes around the base of the modules.
- Reinstall with suitable backfill and topsoil to finished design level.
- Ensure that the Puraflo lids are securely fastened.

7.6 Electrical Connections

- Select a location for the electrical control panel near the pump tank.
- Install the cable between the power source and the control panel in accordance with local regulations.
- Place the electrical power cable(s) in the trench / conduit (leaving the cable un-stretched). Connect each cable coming from the equipment in the pump tank in accordance with the wiring diagram located on the door of the control panel (a typical wiring schematic is detailed

below). The cable between the pump tank and the control panel is to be installed in conduit. Reinstall area.

- Connect the electrical power cable(s) to an independent electrical power supply of the specified voltage (usually 115 volts), terminating in a socket or junction box protected by an M.C.B. as required (usually 20 amps). If a duplex control panel or high head pump is required the voltage and amperage requirements may increase.

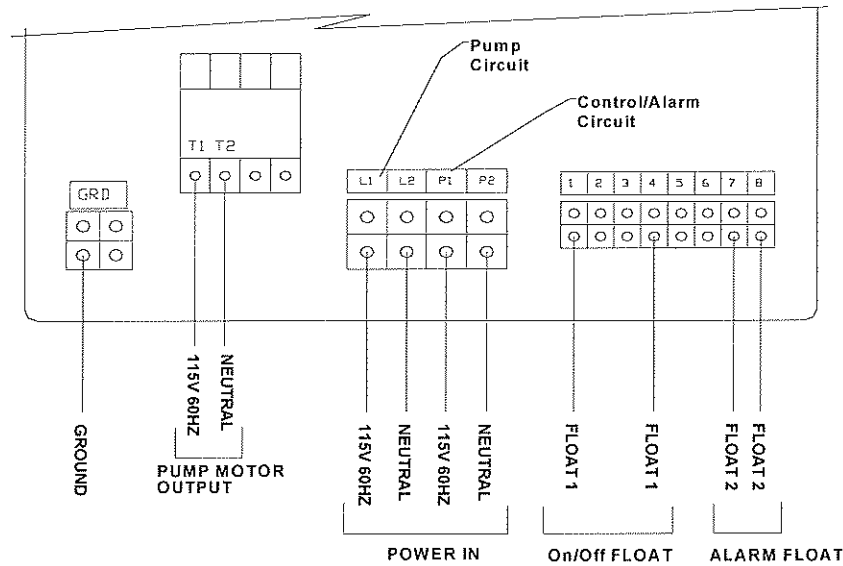

**Typical Wiring Schematic for a simplex pump system.
Please refer to the inside of the Control Panel for the
actual wiring diagram and specifications.**

7.7 Spare Parts

Spare or replacement parts can be obtained from the manufacturer of the component or Bord na Mona should component defects become evident.

7.8 Site Restoration

- The modules can be installed at grade or above grade with the ground landscaped to divert storm water away from the modules.
- Backfill around modules to a height just under the lid of the modules. Grade the backfill back to the existing ground level on a slope no steeper than 2:1. Backfill should be suitable, loose,

workable material. Compact backfill sufficiently to counteract settlement. The final layer (6 inches) of fill material should be suitable topsoil capable of supporting vegetative growth.

- Grass seed and straw the sloped backfill area and any trench excavation lines with a suitable indigenous seed variety. In some cases, sodding for immediate stabilization may be specified.
- Provide erosion protection as required per design plan.

Appendix 1. Typical Septic Tank and Pump Tank Detail.

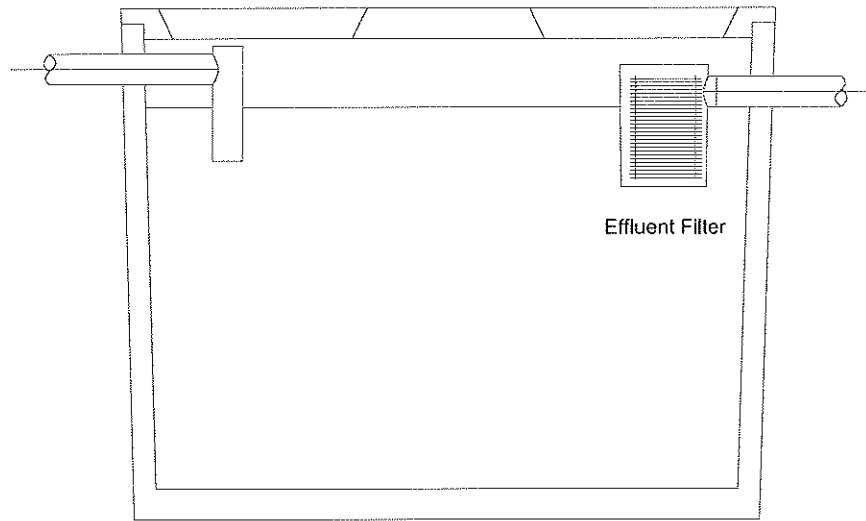

OREGON APPROVED SEPTIC TANK DETAIL
 (dimensions, construction and installation should conform to applicable local and state regulations)

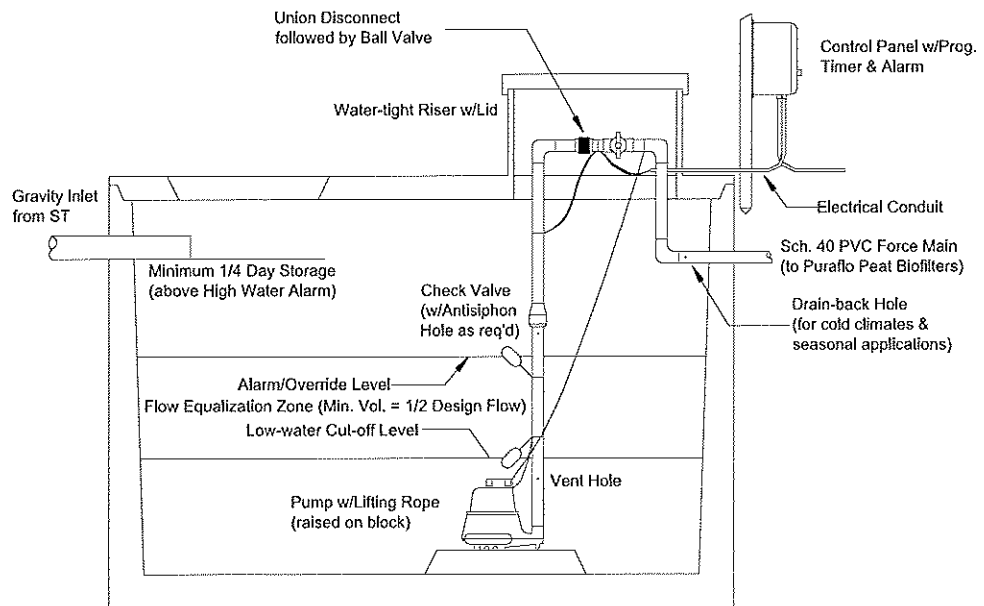

TYPICAL PUMP TANK DETAIL
 (dimensions, construction and installation should conform to applicable local and state regulations)

Appendix 2. Type B Installation.

TYPE B - PIPED OUTLET INSTALLATION

